

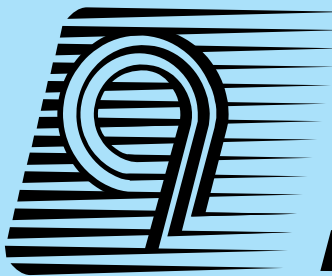

## 2010 Catalog and Price List



# ***PERFECTOR SCIENTIFIC***

**Our Guarantee: Your Satisfaction or your money back!**



# Perfector Scientific<sup>®</sup> Laboratory Plasticware

## About Perfector Scientific:

We were established in 1977 to offer you, the serious scientific instrument user, a fast method of receiving the finest quality accessories at a reasonable price. Pleasant, friendly technical help is just a phone call away. We go to great lengths to keep products in stock so that they can be shipped to you quickly, usually the same day that you call in an order. All of our products are guaranteed to perform at least as well as the specifications listed in the catalog. Any product that we sell may be returned to us within 10 days if you are not satisfied with it for any reason. No questions asked! We take good service seriously.

## Our Guarantee

All of our products are guaranteed to perform as indicated in the catalog. If you are not satisfied for any reason please call us within 10 days for a return authorization. Any item may be returned without question within this 10 day period!

## Shipment

All orders are FOB Atascadero, CA. Shipping charges are added to your invoice. All of our products are shippable via UPS. Most of our products are bulky so shipping via UPS ground service is usually preferable. If you need the shipment faster, we have all levels of UPS service available.

## No Minimum Order

Order just what you need! We are here to serve you.

## How to Order

On your orders please specify our catalog number, description, quantity, your purchase order, shipping and billing address, and a phone number that we can call you at if we have questions.

## Pricing Policy

The prices listed in the catalog are those in effect at publication time and are subject to change without notice. Having said that, we try to keep price increases to a minimum.

## Payment Terms

MasterCard, VISA, American Express or net 30 days to recognized accounts.

*Phone Hours 8:30am to 4:30pm Pacific*

<b>Products:</b>	<b>Page</b>
Autoanalyzer Cups	17
Centrifuge Tubes	3, 17
Cryo-Store <sup>®</sup> Vials	10-11
Culture Tubes	14-16
Cuvettes, Disposable	24
Microcentrifuge Tubes	7-9
Microcentrifuge Tube Boxes	9
Multi-Vials	13
Pipet Tips	4-6
Pipets, Transfer	20-23
Securi-Vials	12
Specimen Cups	17
Test Tubes	14-16
Transfer Pipets	20-23
Transport Tubes	18-19
Vials	12-13
Weigh Boats	17

### Mail Orders to:

**Perfector Scientific<sup>®</sup>**  
**PO Box 91**  
**Atascadero, CA 93423**

### USA Phone Orders to:

**(800) 362-6099**

### Outside USA Phone calls:

**(805) 466-8497**

### Fax Orders to:

**(805) 461-1575**

### e-mail

**info@perfector.com**

### World Wide Web

**http://www.perfector.com**

# Centrifuge Tubes, 15 ml and 50 ml



## 15 ml Conical Centrifuge Tubes with Screwcaps

Our tightly sealing 15ml Conical Centrifuge tubes are excellent for sample collection, processing and storage. The blue caps have a molded sealing ring to provide a tight, leak-proof seal. The outer edge of the caps are ribbed, making removal easy even with wet hands.

The tubes are available in either polystyrene or polypropylene. The polystyrene is crystal clear while the polypropylene is clear enough to view easily the sample on the interior. Packaging is either bulk, sterilized tray pack or sterilized bulk pack. The non-sterilized bulk pack is 500 tubes and caps with the tubes and caps in separate bags. The sterilized tray pack contains 10 trays of 50 tubes with caps attached (total 500 tubes and caps), each tray is packaged separately. The sterilized bulk pack contains 20 bags of 25 tubes with caps attached (total 500 tubes and caps). Tubes that are sterile are sterilized by gamma radiation.

All tubes and caps are sold by the pack of 500.

### Tubes with Molded Graduations:

These tubes are graduated in increments of 0.1ml up to 1ml and then in increments of 0.5ml up to 15ml. The markings are molded into the body of the tubes.

Catalog#	Description	Material	Sterilized	Pack	Price
2600	15ml Screwcap Tubes	Polystyrene	no	bulk	\$ 55.00
2605	15ml Screwcap Tubes	Polypropylene	no	bulk	55.00
2610	15ml Screwcap Tubes	Polystyrene	yes	25/bag	65.00
2615	15ml Screwcap Tubes	Polypropylene	yes	25/bag	65.00
2620	15ml Screwcap Tubes	Polystyrene	yes	tray	75.00
2625	15ml Screwcap Tubes	Polypropylene	yes	tray	75.00

### Tubes with Printed Graduations:

These tubes are graduated in increments of 1ml from 2 to 15ml. The graduations are silkscreened on to the tubes with a chemical resistant blue ink.

Catalog#	Description	Material	Sterilized	Pack	Price
2600/P	15ml Screwcap Tubes	Polystyrene	no	bulk	\$ 65.00
2605/P	15ml Screwcap Tubes	Polypropylene	no	bulk	65.00
2610/P	15ml Screwcap Tubes	Polystyrene	yes	25/bag	75.00
2615/P	15ml Screwcap Tubes	Polypropylene	yes	25/bag	75.00
2620/P	15ml Screwcap Tubes	Polystyrene	yes	tray	85.00
2625/P	15ml Screwcap Tubes	Polypropylene	yes	tray	85.00



## 50 ml Conical Centrifuge Tubes with Screwcaps

Our 50ml conical centrifuge tubes offer you the finest tubes for Tissue Culture, Microbiology, Virology, sample collection, sample storage as well as many other laboratory functions. The tight sealing blue screw caps have a special sealing ring molded in, allowing such a tight seal that the tubes may be used for specimen transport with no risk of leakage.

The tubes are molded of research grade polypropylene copolymer which is selected for strength and clearness. Graduations are molded into the centrifuge tube body in 2.5ml increments from 0 to 10ml and in 5ml increments up to 50ml. Tubes and caps are available in either sterilized (by gamma radiation) or non-sterilized packs. The tray pack is pictured above, the bulk pack is in plastic bags. All tubes are sold with caps in packs of 500. All tubes are packaged with the caps attached except catalog number 2650 and 2650/P which have the caps packaged in a separate bag.

All tubes and caps are sold by the pack of 500.

### Tubes with Molded Graduations:

Graduations are molded into the centrifuge tube body in 2.5ml increments from 0 to 10ml and in 5ml increments up to 50ml. The markings are molded into the body of the tubes.

Catalog#	Description	Sterilized	Tubes/pack	Pack	Price
2650	50 ml Tube with cap	no	500	bulk	\$ 69.00
2655	50 ml Tube with cap	no	500	bags of 25	95.00
2660	50 ml Tube with cap	no	500	trays of 25	105.00
2670	50 ml Tube with cap	yes	500	bags of 25	95.00
2675	50 ml Tube with cap	yes	500	trays of 25	119.00

### Tubes with Printed Graduations:

These tubes are graduated in increments of 5ml from 5 to 50ml. The graduations are silkscreened on to the tubes with a chemical resistant blue ink.

Catalog#	Description	Sterilized	Tubes/pack	Pack	Price
2650/P	50 ml Tube with cap	no	500	bulk	\$ 79.00
2655/P	50 ml Tube with cap	no	500	bags of 25	105.00
2660/P	50 ml Tube with cap	no	500	trays of 25	125.00
2670/P	50 ml Tube with cap	yes	500	bags of 25	109.00
2675/P	50 ml Tube with cap	yes	500	trays of 25	135.00

# PerfectorTips™ Pipet Tips

## Premium Pipettor Tips

Our pipettor tips are unique in several ways:

We take the greatest pride possible in offering you the highest quality disposable plasticware available. The injection molding machines are checked after each run and each molded plastic piece is visually inspected one by one. We use only the finest, virgin polypropylene. All of our dyes are organic (no metallic dyes) and will not leach into your sample.

*Guaranteed To Fit your pipettor!*

Perfector Tips are guaranteed to form an airtight seal on your pipettor barrel and allow ejectors to work well.

*Guaranteed Excellent Performance!*

Highly accurate intake and dispensing of samples to the maximum specification of your pipettor.

*Guaranteed Always in Stock!*

We keep a large inventory so that we can ship your orders quickly. Most orders are shipped the same day that we receive your order.

## Packaging Options:

Package Type	Description	Tips/pack	Tips/rack
Zip Lock Bag	Bulk package	1000	-
96 tip rack	Autoclavable rack for small tips	960	96
100 tip rack	Autoclavable rack for larger tips	1000	100
200 tip rack	Stack rack, non-autoclavable rack	1000	200
single wrap sterile	Bulk pack of sterilized tips	500	-



200 tip open racks

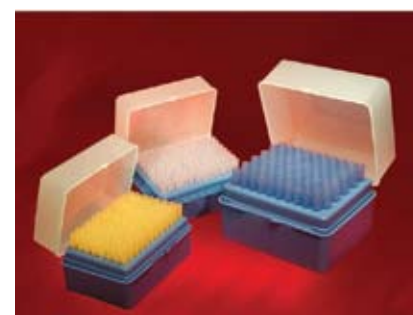

96 and 100 tip autoclavable racks



1670-N



1670-Y

## Universal Pipet Tips

### 1 - 200µL (small)

To fit pipettors manufactured by:

**Pipetman, Eppendorf, MLA, Oxford, Titertek, Finnpipe, Socorex and most multichannel pipettors.**

This pipet tip is designed to meet the greatest range of your pipeting needs in one tip. It fits all of the above manufacturers' pipettors, and is graduated at 10, 20, 50, 100 and 200µL. Either natural (no dye) or yellow color available. All tips are made of either yellow or natural color polypropylene with enhanced clarity for easier sample viewing.

Catalog#	Package type	Color	Quantity	Price/pk
1670-N	Zip lock bag	natural	1000	\$ 15.00
1670-Y	Zip lock bag	yellow	1000	\$ 15.00
1770-N	200 tip rack	natural	1000	\$ 24.50
1770-Y	200 tip rack	yellow	1000	\$ 24.50
1870-N	96 tip rack	natural	960	\$ 35.00
1870-Y	96 tip rack	yellow	960	\$ 35.00



1674-N

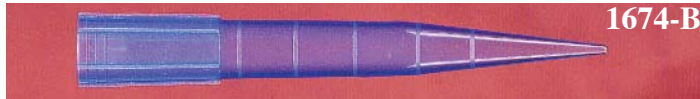

1674-B

## Universal Pipet Tips

### 100 - 1000µL (medium)

To fit pipettors manufactured by:

**Pipetman, Eppendorf and many others...**

This pipet tip is designed to meet the greatest range of your pipeting needs in one tip. It fits the above manufacturers' pipettors, and is graduated at 100, 250, 500, 750 and 1000µL. Either natural (no dye) or blue color available. All tips are made of either blue or natural color polypropylene with enhanced clarity for easier sample viewing.

Catalog #	Package type	Color	Quantity	Price/pk
1674-N	Zip lock bag	natural	1000	\$ 17.00
1674-B	Zip lock bag	blue	1000	\$ 17.00
1774-N	200 tip rack	natural	1000	\$ 27.50
1774-B	200 tip rack	blue	1000	\$ 27.50
1874-N	96 tip rack	natural	960	\$ 39.00
1874-B	96 tip rack	blue	960	\$ 39.00

# PerfectorTips™ Pipet Tips to fit pipettors by:

## Pipetman® , Gilson® , Rainin®

Catalog #	Volume	Color	Package	Qty/pack	Price/Pk
1615	10 µl	natural	zip lock bag	1000	\$ 17.00
1670-Y	250 µl	yellow	zip lock bag	1000	\$ 15.00
1770-Y	250 µl	yellow	200 tip rack	1000	\$ 24.50
1912-Y	250 µl	yellow	96 tip rack	960	\$ 37.50
1670-N	250 µl	natural	zip lock bag	1000	\$ 15.00
1770-N	250 µl	natural	200 tip rack	1000	\$ 24.50
1674-B	1000 µl	blue	zip lock bag	1000	\$ 17.00
1774-B	1000 µl	blue	200 tip rack	1000	\$ 27.50
1682	5000 µl	natural	zip lock bag	1000	\$ 58.50
1684	10 ml	natural	zip lock bag	200	\$ 41.50

## Oxford®

Catalog #	Volume	Color	Package	Qty/pack	Price/Pk
1614	0.1 - 10 µl	natural	zip lock bag	1000	\$ 17.00
1614-R	0.1 - 10 µl	natural	100 tip rack	1000	\$ 39.00
1670-N	5-200 µl	clear	zip lock bag	1000	\$ 15.00
1770-N	5-200 µl	clear	200 tip rack	1000	\$ 24.50
1605	500-1000 µl	green	zip lock bag	1000	\$ 21.50
1610	201-1000 µl	blue	zip lock bag	1000	\$ 18.50
1682	5 ml	natural	zip lock bag	1000	\$ 58.50

## Eppendorf®

Catalog #	Volume	Color	Package	Qty/pack	Price/Pk
1614	10 µl	natural	zip lock bag	1000	\$ 17.00
1814	10 µl	natural	100 tip rack	1000	\$ 39.00
1670-Y	200 µl	yellow	zip lock bag	1000	\$ 15.00
1770-Y	200 µl	yellow	200 tip rack	1000	\$ 24.50
1610	1000 µl	blue	zip lock bag	1000	\$ 18.50
1682	5 ml	natural	zip lock bag	1000	\$ 58.50

## MLA®

Catalog #	Volume	Color	Package	Qty/pack	Price/Pk
1607	1-200 µl	clear	zip lock bag	1000	\$ 15.00
1707	1-200 µl	clear	200 tip rack	1000	\$ 24.50
1608	201-1000 µl	clear	zip lock bag	1000	\$ 16.00
1682	5 ml	clear	zip lock bag	1000	\$ 58.50

## Finnpipette®

Catalog #	Volume	Color	Package	Qty/pack	Price/Pk
1670-N	1-200 µl	clear	zip lock bag	1000	\$ 15.00
1670-Y	1-200 µl	yellow	zip lock bag	1000	\$ 15.00
1770-N	1-200 µl	clear	200 tip rack	1000	\$ 24.50
1605	200-1000 µl	green	zip lock bag	1000	\$ 21.50
1686	5 ml	natural	zip lock bag	1000	\$ 58.50

## Capillary Pipet Tips

Our capillary pipettor tips are designed for use with Gel Loading. The small extended sample delivery tip allows for accurate delivery with no sample loss. For use with ultra micro pipettors from several makers including Eppendorf®, Pipetman®, Finnpipette®. Natural color, packed **1000 tips per pack**.

Catalog #	Volume	Package	Price/Pk
<b>1590</b>	1-200 µl	zip lock bag	\$ 36.50



### Cross Reference for tips not listed:

#### For this pipettor

Abbott Macro  
Excalibur  
Helena Macro  
Pfizer Macro  
SMI, 5-200 ul

#### Use these tips

Oxford tip  
Pipetman  
Oxford tip  
Oxford tip  
MLA

#### For this pipettor

SMI, 101-1000µl  
SMI Macro  
Socorex  
Volac

#### Use these tips

Pipetman  
Finnpipette tip  
Pipetman  
Pipetman

# PerfectorTips™ Large Volume Pipet Tips

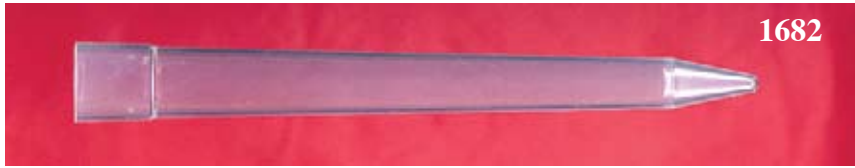

This macro pipet tip has a useable volume range of 1 to 5 ml. It is made of natural colored polypropylene and is autoclavable. The tips are sold in a case of 1,000 tips. The case of 1,000 contains 4 ziplock bags of 250 tips per bag.

Fits 1-5ml pipettors made by: **Pipetman®**, **MLA®**, **Oxford-Benchmate®**, **Rainin EDP2®**, **Socorex®** and **Volac®**, and others

Catalog Number	Description	Volume	Color	Package	Tips/pack	Price/Pk
1682	Macro Pipet Tip	1 to 5 ml	natural	zip lock bag	1000	\$ 58.50



This macro pipet tip has a useable volume range of 1 to 5 ml. It is made of natural colored polypropylene and is autoclavable. The tips are sold in a case of 1,000 tips. The case of 1,000 contains 4 ziplock bags of 250 tips per bag.

Fits 1-5ml pipettors made by: **Finnpipette®**, **SMI®** and others

Catalog Number	Description	Volume	Color	Package	Tips/pack	Price/Pk
1686	Macro Pipet Tip	1 to 5 ml	natural	zip lock bag	1000	\$ 58.50



This macro pipet tip has a useable volume range of 1 to 5 ml. It is made of natural colored polypropylene and is autoclavable. The tips are sold in a case of 1,000 tips. The case of 1,000 contains 4 ziplock bags of 250 tips per bag.

Fits 1-5ml pipettors made by: **Finnpipette®**, **SMI®** and others

Catalog Number	Description	Volume	Color	Package	Tips/pack	Price/Pk
1688	Macro Pipet Tip	1 to 5 ml	natural	zip lock bag	1000	\$ 58.50



This macro pipet tip has a useable volume range of 1 to 10 ml. It is made of natural colored polypropylene and is autoclavable. The tips are sold in a pack of 200 tips. Each pack is a single zip lock bag containing 200 tips.

Fits 1-5ml pipettors made by: **Finnpipette®**, **SMI®** and others

Catalog Number	Description	Volume	Color	Package	Tips/pack	Price/Pk
1684	Macro Pipet Tip	1 to 10 ml	natural	zip lock bag	200	\$ 41.50

# Screw-Cap Microcentrifuge Tubes



Our new screw-cap microcentrifuge tubes and caps are made entirely of autoclavable polypropylene. They are available in two designs; one with a conical exterior bottom and another with a flat skirt which allows the tubes to be free standing. Both types have

conical interior bottoms. Screw caps are available both with and without "O" rings. The screw caps seal liquid tight without the "O" rings but are gas tight with the "O" rings. The caps are available in colors for easy identification and dating.

Catalog #	Description	Volume	Exterior	Color	Tubes/Pack	Price/Pack
6500	Screw-cap Microcentrifuge Tube	0.5 ml	Conical	Natural	500	\$ 16.50
6510	Screw-cap Microcentrifuge Tube	0.5 ml	Free Standing	Natural	500	\$ 16.50
6520	Screw-cap Microcentrifuge Tube	1.5 ml	Conical	Natural	500	\$ 16.50
6530	Screw-cap Microcentrifuge Tube	1.5 ml	Free Standing	Natural	500	\$ 16.50
6540	Screw-cap Microcentrifuge Tube	2.0 ml	Conical	Natural	500	\$ 16.50
6550	Screw-cap Microcentrifuge Tube	2.0 ml	Free Standing	Natural	500	\$ 16.50

## Caps for Screw-Cap Micro Tubes

Catalog #	Description	"O" Ring	Color	#/Pack	Price/pk
6570	Cap	no	Red	500	\$ 16.50
6571	Cap	no	Blue	500	\$ 16.50
6572	Cap	no	Green	500	\$ 16.50
6573	Cap	no	Yellow	500	\$ 16.50



Catalog#	Description	"O" Ring	Color	#/Pack	Price/pk
6580	Cap with "O" ring	yes	Red	500	\$ 29.00
6581	Cap with "O" ring	yes	Blue	500	\$ 29.00
6582	Cap with "O" ring	yes	Green	500	\$ 29.00
6583	Cap with "O" ring	yes	Yellow	500	\$ 29.00

## Sterilized Screw-Cap Micro Tubes

We have packaged the screw cap microcentrifuge tubes as listed above in smaller sealed bags containing both the tubes and the caps. These have then been sterilized by gamma radiation. The caps are natural in color and are equipped with the "O" ring seal

as described above. Each pack contains a total of 500 tubes and caps with fitted "O" rings. Within each pack is 10 sealed bags containing 50 tubes and caps. The tubes are available with either the conical exterior or the free standing bottom.

Catalog #	Description	Volume	Exterior	Color	Quantity/Pk	Price/Pk
5405	Sterilized Screw-cap Microcentrifuge Tube	0.5 ml	Conical	Natural	500	\$ 59.00
5415	Sterilized Screw-cap Microcentrifuge Tube	0.5 ml	Free Standing	Natural	500	\$ 59.00
5425	Sterilized Screw-cap Microcentrifuge Tube	1.5 ml	Conical	Natural	500	\$ 59.00
5435	Sterilized Screw-cap Microcentrifuge Tube	1.5 ml	Free Standing	Natural	500	\$ 59.00
5445	Sterilized Screw-cap Microcentrifuge Tube	2.0 ml	Conical	Natural	500	\$ 59.00
5455	Sterilized Screw-cap Microcentrifuge Tube	2.0 ml	Free Standing	Natural	500	\$ 59.00

# Microcentrifuge Tubes

These tubes are a direct replacement for the tubes that you are now using but with some added features. Our microtubes are molded from colored polymer materials. This makes these tubes ideal for sorting, identification of contents, indication of standard specimens from biohazards as well as dating of use. Colors available are natural, pink, yellow, blue, or green. Caps are attached and snap tightly when closed. All colors are organic dyes containing no metals and will not leach any foreign materials. Quality virgin polyethylene and polypropylene is used to eliminate the possibility of splitting or leakage. 100% guaranteed to perform to your satisfaction or your money back!

## 0.4 ml

Polyethylene tubes  
45mm long, 6mm diameter OD.  
No Graduations, Dimpled top  
Maximum Force (RCF) 12,000  
1000 per pack

<b>Catalog #</b>	<b>Color</b>	<b>Price</b>
2800	Natural	\$27
2801	Pink	\$27
2802	Yellow	\$27
2803	Blue	\$27
2804	Green	\$27



## 0.5 ml

Polypropylene tubes  
30mm long, 7mm diameter OD.  
Graduations at 0.5, 0.4, 0.3, 0.2, 0.1 ml  
Flat top  
Maximum Force (RCF) 18,000  
1000 per pack

<b>Catalog #</b>	<b>Color</b>	<b>Price</b>
2820	Natural	\$27



## 1.5 ml

Polypropylene tubes  
38mm long, 11mm diameter OD.  
Graduations at 1.5, 1.0, 0.5, 0.1 ml  
Flat top  
Maximum Force (RCF) 18,000  
1000 per pack

<b>Catalog #</b>	<b>Color</b>	<b>Price</b>
2840	Natural	\$27
2841	Pink	\$27
2842	Yellow	\$27
2843	Blue	\$27
2844	Green	\$27
2849	Assorted	\$27



# Microcentrifuge Tubes

## 2.0 ml

Polypropylene tubes  
 40mm long, 10mm diameter OD.  
 Graduations at 2.0, 1.5, 1.0, 0.5 ml  
 Flat top  
 Maximum Force (RCF) 18,000  
 1000 per pack

Catalog #	Color	Price
4860	Natural	\$35
4869	Assorted	\$35



## RNase/DNase Free Microtubes

These microtubes have been tested and certified to be free of RNase and DNase. They are made of polypropylene and are natural color. Each tube is graduated and has a flat snap top. There is a frosted area on the tube for writing. The tubes are manufactured with our "Low Adhesion" resin which minimizes liquid retention and allows for maximum sample yield.

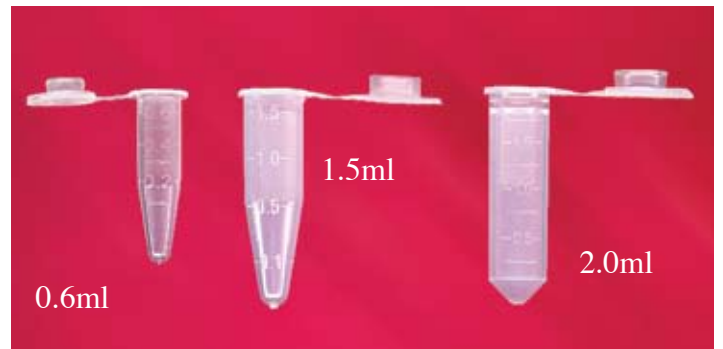

Catalog #	Volume	Tubes/pack	Price/pack
3200	0.6 ml	1000	\$ 26.50
3220	1.5 ml	500	\$ 16.50
3240	2.0 ml	500	\$ 19.50

**\*Note:** For the 2.0ml Microtube - Centrifuges that develop excessive heat may damage this tube. It is designed for short runs with no more than 13,000xG in centrifuges with adequate ventilation.

## Microcentrifuge Tube Storage Boxes

### Microtube Storage and Transport Box

These new Storage boxes are designed to contain up to 50 microtubes (1.5mL size) or other small vials. The telescopic lid is adjustable for tubes up to 56 mm in length. The boxes are made of translucent polypropylene that will work in both autoclave and freezer. Compact size (1 3/4" x 3" x 5 3/4") makes efficient use of valuable freezer space. Available in a pack of 5 boxes and lids.

Catalog#	Description	Price/pack
2870	Microtube Box, 5 per pack	\$ 19.50



# Perfactor Cryo-Store<sup>®</sup> Low Temperature Vials



### Cardboard Freezer Storage Box

This partitioned cardboard box with lid will hold up to 100 Cryo-Stor<sup>®</sup> vials for storage in your freezer. The box is 3" high by 5 1/4" square. (vials not included)

Catalog#	Description	Price, Each
CV03-0303	Cryo-Store <sup>®</sup> Cardboard box	\$ 8.50

### Cryo-Store<sup>®</sup> Rack

- \* Hold up to 50 Cryo-Store<sup>®</sup> Vials
- \* Grips Vials at bottom so caps may be twisted on and off easily with one hand
- \* One rack fits all sizes of Cryo-Store Vials.

Our Cryo-Store<sup>®</sup> Vial rack is designed to make large numbers of Cryo-Store<sup>®</sup> Vials easy to use, store and move. Each row is lettered and each column is numbered so that Vials may be easily identified. In the bottom of each well in the rack are interlocking ribs which allow for easy insertion and removal but will not allow the vials to turn making the caps easy to twist on and off with one hand. The rack is 7 3/4" long, 4 1/8" wide and 1" high. Each vial well has a hole for drainage of spills. The rack is autoclavable.

Catalog#	Description	Price, Each
2189	Cryo-Store <sup>®</sup> Vial Rack	\$ 15.00



# Perfector Cryo-Store® Low Temperature Vials

- \* Threaded Caps
- \* Conical Interior Bottom, Flat Exterior Bottom
- \* Volume Graduations
- \* Specimen easily viewed
- \* Will not crack in Nitrogen Vapor

Our Cryo-Store® Freezing Vials are designed for storing and transporting specimens at very low temperatures. Made of non-toxic polyallomer, these vials not only provide the strength needed for low temperature storage but are also clear enough to see easily the sample within. The threads on the vial are molded out of the exterior leaving the interior smooth for easy sample extraction. The interior bottom is conical for maximum sample recovery while the exterior bottom is flat so that the vials will stand up on their own. The bottom “skirt” that forms the flat exterior bottom is ribbed to give wet fingers grip for screwing on the cap.

The unique threaded cap has a molded-in sealing ring which assures a tight, leakproof seal without the need of a washer. The screw caps are included and are available in various colors. The available colors are red, blue, green, yellow and white. If you do not specify cap color we will supply blue caps. Graduations are molded in at 0.5ml increments. A label area is molded in for easy writing with a pencil or felt tip pen.

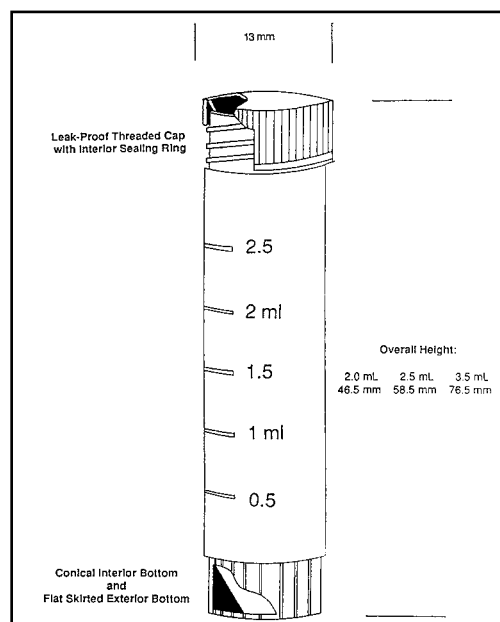

Available as bulk packs and Gamma Radiation Sterilized. Each bulk pack case contains 1,000 tubes and caps. The tubes are packed 250 per zip lock bag with the 1,000 caps in a single zip lock bag. The case of sterilized tubes is supplied as 10 sealed bags of 100 tubes and caps each.

Catalog#	Description	Volume	Cap Color	Sterilized	Case Quantity	Price/case
<b>Non-sterilized:</b>						
2190/BLUE	Cryo-Store® Vials, small	2.0 ml	Blue	no	1000 tubes and caps	\$ 62.50
2190/GREEN	Cryo-Store® Vials, small	2.0 ml	Green	no	1000 tubes and caps	\$ 62.50
2190/RED	Cryo-Store® Vials, small	2.0 ml	Red	no	1000 tubes and caps	\$ 62.50
2190/WHITE	Cryo-Store® Vials, small	2.0 ml	White	no	1000 tubes and caps	\$ 62.50
2190/YELLOW	Cryo-Store® Vials, small	2.0 ml	Yellow	no	1000 tubes and caps	\$ 62.50
<b>Sterilized by Gamma Radiation:</b>						
2191/BLUE	Cryo-Store® Vials, small	2.0 ml	Blue	yes	1000 tubes and caps	\$ 119.00
<b>Non-sterilized:</b>						
2194/BLUE	Cryo-Store® Vials, medium	2.5 ml	Blue	no	1000 tubes and caps	\$ 67.50
2194/GREEN	Cryo-Store® Vials, medium	2.5 ml	Green	no	1000 tubes and caps	\$ 67.50
2194/RED	Cryo-Store® Vials, medium	2.5 ml	Red	no	1000 tubes and caps	\$ 67.50
2194/WHITE	Cryo-Store® Vials, medium	2.5 ml	White	no	1000 tubes and caps	\$ 67.50
2194/YELLOW	Cryo-Store® Vials, medium	2.5 ml	Yellow	no	1000 tubes and caps	\$ 67.50
<b>Sterilized by Gamma Radiation:</b>						
2195/BLUE	Cryo-Store® Vials, medium	2.5 ml	Blue	yes	1000 tubes and caps	\$ 129.00
<b>Non-sterilized:</b>						
2198/BLUE	Cryo-Store® Vials, large	3.5 ml	Blue	no	1000 tubes and caps	\$ 71.50
2198/GREEN	Cryo-Store® Vials, large	3.5 ml	Green	no	1000 tubes and caps	\$ 71.50
2198/RED	Cryo-Store® Vials, large	3.5 ml	Red	no	1000 tubes and caps	\$ 71.50
2198/WHITE	Cryo-Store® Vials, large	3.5 ml	White	no	1000 tubes and caps	\$ 71.50
2198/YELLOW	Cryo-Store® Vials, large	3.5 ml	Yellow	no	1000 tubes and caps	\$ 71.50
<b>Sterilized by Gamma Radiation:</b>						
2199/BLUE	Cryo-Store® Vials, large	3.5 ml	Blue	yes	1000 tubes and caps	\$ 139.00

# Securi-Vials, threaded top vials



## 1/2 Turn Screw Caps

### Securi-Vial, 7ml

Securi-Vials are excellent for scintillation counting as they have a low background count and are clear enough for specimen viewing and fill checking. They hold up to 7ml and have a dimpled bottom for use with filter paper counting. Our new polypropylene copolymer resin will take colder cold and autoclave heat without distortion or cracking. Our screw closures require only one half turn from open to tightly sealed. This saves effort if you need to process many samples. Securi-Vials are available in either a bulk pack or in a tray pack. Each tray consists of 4 trays which hold 250 vials upright ready for filling with the caps in a compartment on the side. The bulk pack consists of four zip lock bags of 250 vials per bag with one bag of 1000 caps.

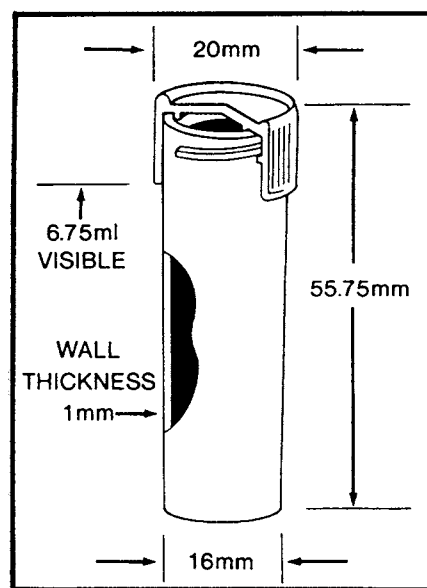

Catalog#	Description	Packaging	Quantity/Pack	Price/pack
2140	Securi-Vial	Bulk	1000 vials and caps	\$ 49.00
2142	Securi-Vial	Tray	1000 vials and caps	\$ 79.00

# Multi-Vials, snap cap vials

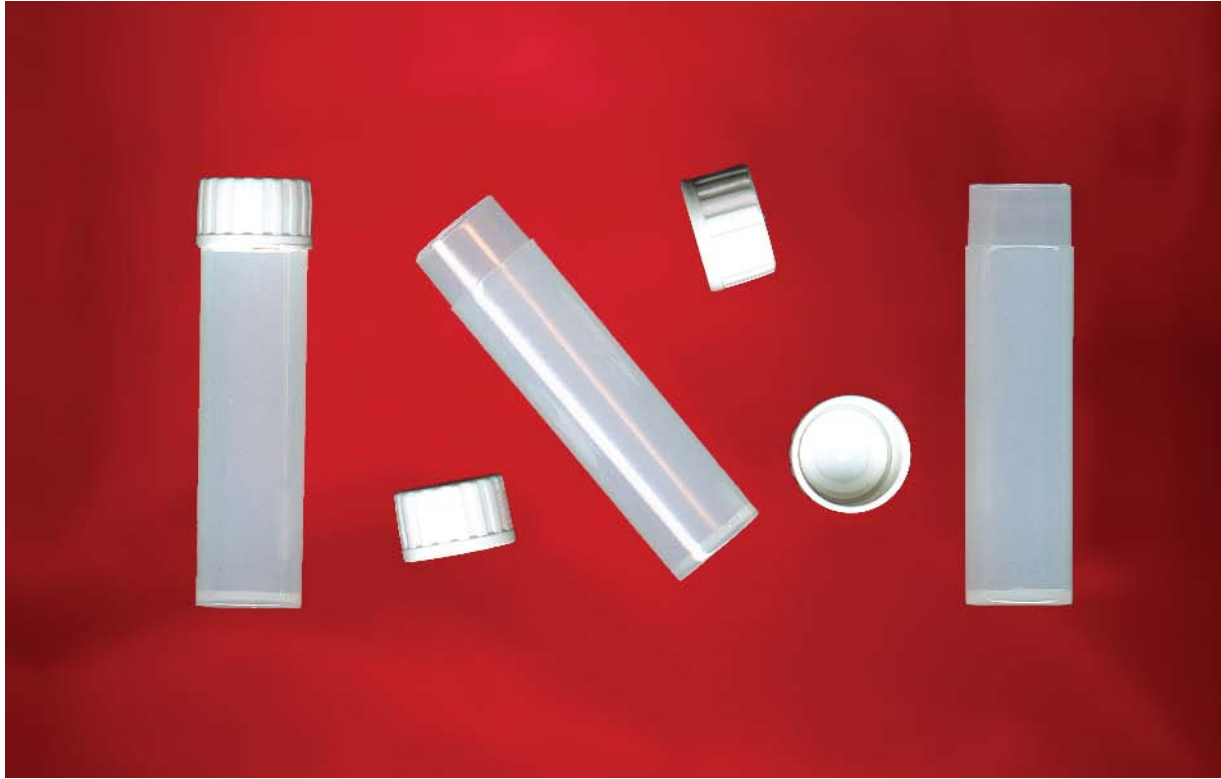

## Snap Caps

### Multi-Vial, 5ml

Multi-Vials are made from a new type of polypropylene which has greater hot and cold strength for autoclaving as well as freezer strength. Low background counts for excellent radioactive counting and a visual clarity not found in other vials so that you may check fill levels and specimen content. "Snap" shut cap makes a liquid tight seal using a special flange seal that is molded into the cap. Nominal volume is 5ml. The bulk pack contains four plastic bags of 250 multi-vials and one bag of 1000 caps. Tray pack contains 5 trays of 200 with caps in side compartment, ready for filling.

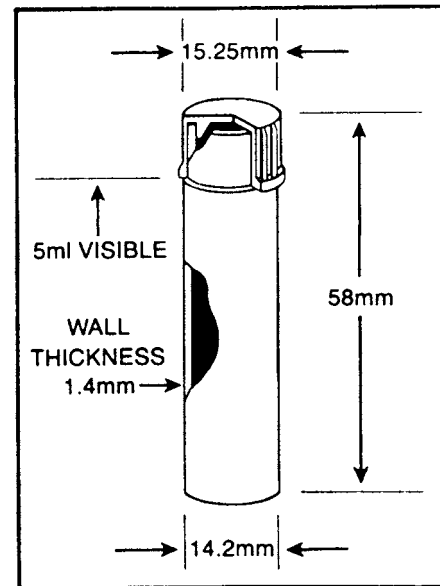

Catalog#	Description	Packaging	Quantity/Pack	Price/pack
2150	Multi-Vial	Bulk	1000 vials and caps	\$ 49.00
2152	Multi-Vial	Tray	1000 vials and caps	\$ 67.50

# Test tubes / Culture tubes

These precision molded test tubes and culture tubes are made from premium polystyrene and polypropylene. No other chemical additives or releasing agents are used in the manufacture, making them excellent for use with RIA, Bacteriology and Coagulation as well as a sample storage and general laboratory use. Polystyrene tubes are crystal clear and are not autoclavable. Polypropylene tubes are autoclavable and are available in colors which make sample identification and dating much easier.

## Packaging:

Most of our tubes are available in either bulk pack (zip lock bags) or tray pack (cardboard tray with cardboard slip cover). We keep a large stock of all tubes and caps so that we can ship your order within 24 hours under most circumstances.

## 12 x 55mm Tubes (caps sold separately)

These smaller tubes are excellent in applications where lower volumes are needed. Tubes are packaged in 4 zip lock bags of 250 each. Nominal volume: 3 ml

Cat#	Description	Material	Qty/Pack	Pkg	Price/Pk
2340	12x55 Tubes	Polystyrene	1000	Bulk	\$ 26.50
2345	12x55 Tubes	Polypropylene	1000	Bulk	\$ 26.50



## 12 x 75mm Conical (Caps sold separately)

Conical tube bottoms are designed for use in centrifugation. They are also good for complete sample recovery. Tubes and caps are sold separately as packs of 1,000. Bulk tubes are packaged in 4 zip lock bags of 250 each. Nominal volume 5ml.

Cat#	Description	Material	Qty/Pack	Pkg	Price/Pk
2380	12x75 Conical	Polystyrene	1000	Bulk	\$ 23.50
2382	12x75 Conical	Polypropylene	1000	Bulk	\$ 24.50



## 12 x 75mm Tubes (Caps sold separately)

Tubes and caps are sold separately as packs of 1,000. Bulk pack tubes are packaged in 4 zip lock bags of 250 each, trays are packed in 4 trays of 250 tubes each. Nominal volume is 5ml.

Cat #	Description	Material	Color	Qty	Pack	\$/Pack
2320	12x75 Tubes	Polystyrene	Clear	1000	Bulk	\$ 23.50
2322	12x75 Tubes	Polystyrene	Clear	1000	Tray	\$ 30.50
2330	12x75 Tubes	Polypropylene	Natural	1000	Bulk	\$ 24.50
2331	12x75 Tubes	Polypropylene	Blue	1000	Bulk	\$ 24.50
2332	12x75 Tubes	Polypropylene	Green	1000	Bulk	\$ 24.50
2333	12x75 Tubes	Polypropylene	Yellow	1000	Bulk	\$ 24.50
2334	12x75 Tubes	Polypropylene	Red	1000	Bulk	\$ 24.50
2360	12x75 Tubes	Polypropylene	Natural	1000	Tray	\$ 30.50

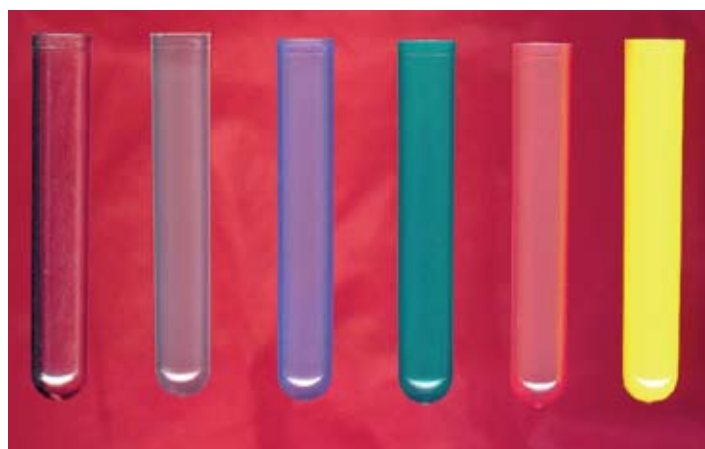

## 12 x 75mm Tubes, Sterilized

These are the same tubes as listed above and they are packaged with the Catalog# 2114 two position cap attached in 8 sealed bags of 125 tubes and caps. All tubes and caps are sterilized by gamma radiation.

## Tubes and Caps, Sterilized

Cat #	Description	Material	Color	Qty	Pack	\$/Pack
2328	12x75 Tubes	Polystyrene	Clear	1000	Sterile	\$ 82.50
2338	12x75 Tubes	Polypropylene	Natural	1000	Sterile	\$ 82.50

# Caps for 12mm Tubes



## Standard Plug Caps: (fit all 12mm diameter tubes)

These rigid polyethylene caps are pushed into the tubes closing liquid tight with sealing rings molded into the caps. Ribs are molded into the exterior top of the caps so that they may be removed even with wet hands. These caps are not autoclavable. Many colors are available for easy identification. When mixed with colored tubes the range of combinations is very great.

Cat#	Description	Color	Qty/Pk	Pkg	Price/Pk
2304	Plug Cap	White	1000	Bulk	\$ 12.50
2305	Plug Cap	Blue	1000	Bulk	\$ 12.50
2306	Plug Cap	Green	1000	Bulk	\$ 12.50
2307	Plug Cap	Yellow	1000	Bulk	\$ 12.50
2308	Plug Cap	Red	1000	Bulk	\$ 12.50
2309	Plug Cap	Lavender	1000	Bulk	\$ 12.50
2300	Plug Cap	Assorted	1000	Bulk	\$ 14.50

## Two Position Caps: (fit all 12mm diameter tubes)

The up position of these caps allows for venting, while the down position seals tightly. Molded of Polyethylene, these caps are natural, translucent color and are not autoclavable. Exterior ribs are molded into the caps so that they may be adjusted or removed even with wet hands.

Cat#	Description	Color	Qty/Pk	Pkg	Price/Pk
2114	2 Position	Natural	1000	Bulk	\$ 15.00



## Flanged Plug Caps: (fit all 12mm diameter tubes)

These versatile polyethylene plug caps are pushed into the tubes closing tightly with sealing flanges molded into the cap. They are very pliable making them useful for sealing many types of round tubes including glass culture tubes. They are not autoclavable. The caps are available in colors for easy identification.

Price per bag: \$ 18.00/1000

Catalog #	Color	Catalog #	Color
2230	Natural	2235	Red
2231	Blue	2236	White
2232	Green	2237	Yellow
2233	Lavender	2238	Assorted
2234	Orange		



# Test tubes / Culture tubes

## 13 x 100mm Tubes

Tubes and caps are sold separately as packs of 1,000. Bulk pack tubes are packaged in 4 zip lock bags of 250 each, trays are packed in 4 trays of 250 tubes each. Polyethylene caps are packed in a single bag of 1000 and are plug type. These caps are not autoclavable. Nominal tube volume is 8ml.

### Tubes:

Cat #	Material	Color	Qty/Pack	Package	Price/Pack
2110	Polystyrene	Clear	1000	Bulk	\$ 36.50
2112	Polypropylene	Natural	1000	Bulk	\$ 36.50

### Caps (plug type):

Cat#	Color	Qty/Pack	Package	Price/Pack
2310	Blue	1000	Bulk	\$ 14.50
2311	Green	1000	Bulk	\$ 14.50
2312	Yellow	1000	Bulk	\$ 14.50
2313	Red	1000	Bulk	\$ 14.50
2314	Lavender	1000	Bulk	\$ 14.50
2316	White	1000	Bulk	\$ 14.50
2318	Assorted	1000	Bulk	\$ 17.50



## 16 x 100mm Tubes

Tubes and caps are sold separately as packs of 1,000. Bulk pack tubes are packaged in 2 bags of 500 each. Polyethylene caps are packed in 2 bags of 500. The caps are not autoclavable. Nominal tube volume is 14ml.

### Tubes:

Cat #	Description	Material	Color	Qty/Pack	Pack	Price/Pack
2420	16x100 Tubes	Polystyrene	Clear	1000	Bulk	\$ 41.50
2422	16x100 Tubes	Polypropylene	Natural	1000	Bulk	\$ 41.50

### Caps (plug type):

Cat #	Description	Color	Qty/Pack	Pack	Price/Pack
2430	Plug Cap	White	1000	Bulk	\$ 20.50
2431	Plug Cap	Blue	1000	Bulk	\$ 20.50



## 17 x 100mm Tubes

Tubes and caps are sold separately as packs of 1,000. Bulk pack tubes are packaged in 2 bags of 500 each. Polyethylene caps are packed in 2 bags of 500. The caps are not autoclavable. Nominal tube volume is 16ml.

### Tubes:

Cat #	Description	Material	Color	Qty/Pack	Pack	Price/Pack
2440	17x100 Tubes	Polystyrene	Clear	1000	Bulk	\$ 47.50
2442	17x100 Tubes	Polypropylene	Natural	1000	Bulk	\$ 47.50

### Caps:

Cat #	Description	Color	Qty/Pack	Pack	Price/Pack
2455	2 Position	Natural	1000	Bulk	\$ 22.50

## 17 x 100mm Tubes, Sterilized

These are the same tubes as listed above and they are packaged with the Catalog# 2455 two position cap attached in sealed bags as listed below. Polystyrene tubes are clear, Polypropylene tubes are natural color. All tubes and caps are sterilized by gamma radiation.

### Tubes and Caps, Sterilized:

Cat #	Description	Material	Qty/Bag	Qty/Pk	Pack	Price/Pack
2472	17x100 Tubes	Polystyrene	25	500	Sterile	\$ 79.00
2476	17x100 Tubes	Polypropylene	25	500	Sterile	\$ 79.00



# Perfector Disposable Plasticware



## Autoanalyzer Sample Cups

Exact duplicates of sample cups for the Autoanalyzer instruments but at a much reduced cost. Made of polystyrene with conical bottoms. Packaged in bags of 1,000.

Catalog #	Description	Price/Pack
2701	Sample Cups, 0.50 ml, 1000/pack	19.50
2702	Sample Cups, 1.5 ml, 1000/pack	24.50
2703	Sample Cups, 2.0 ml, 1000/pack	29.50
2704	Sample Cups, 4.0 ml, 1000/pack	36.50

## 15ml Centrifuge Tubes

*Thick walls, non-split*

*Tight sealing plug caps*

*Polystyrene and Polypropylene*

Our precision molded centrifuge tubes are made with extra thick, uniform walls so that they can withstand continuous spinning at 1800 RCF. The tubes are constructed of either crystal clear polystyrene or autoclavable polypropylene. The tubes have graduations at 1/4, 1/2, 1, 2.5, 5, 10, 12, and 15ml molded into the wall. Blue polyethylene plug caps will seal tubes for storage and transport. Leak proof sealing ring design assures proper sealing. Ribbed cap edge makes it easy to remove caps even if your hands are wet. Caps are purchased separately.



Tubes are in bulk packs of 1000 tubes (4 bags of 250) or a tray pack of 1000 (10 trays of 100) for easy filling. Polyethylene plug caps, purchased separately, are packed 1000 per bag. These caps are not autoclavable.

Catalog#	Description	Material	Pack	Price
2181	Centrifuge tube	Polystyrene	bulk	\$ 55.00
2186	Centrifuge tube	Polypropylene	bulk	\$ 55.00
2184	Caps	Polyethylene	bulk	\$ 23.00

## Specimen Cups with Screw-on Lid

*Tight sealing!*

*Threaded Cap*

*4 1/2 ounces*

*Graduated  
in:ounces &  
milliliters*



Our specimen cup is designed for collecting and storing samples while making use as easy as possible. Clear walls allow for viewing contents without opening the lid. Write on area for contents identification with anything from a ball point pen to a felt tip pen. Tight sealing screw type lid allows for multiple sampling and resealing. Polypropylene material is autoclavable. Lid is blue. Also available in individually wrapped cup and lid packs that have been sterilized by 2.5 megaRads of Gamma Radiation.

Catalog #	Description	Qty/Pack	Price/pack
2460	Specimen Cups	500	\$ 59.00
2464	Specimen Cups, sterilized	100	\$ 38.50

## Polymer Weigh Boats



Disposable boats provide the most convenient method for handling liquid and solid balance samples. Close quality control over materials and precision molding ensures a consistent weight for relative ease of taring. Material is non-wetting high impact polystyrene to ensure full delivery of liquid samples. Smooth surface with rounded corners facilitates removal of all powders and granular samples. Flat bottoms provide stability on the balance pan. 500 weigh boats per package.

Catalog #	Description	Size(mm)	Price/pack
2370	Weigh Boat, Small	44x44	\$ 23.50
2372	Weigh Boat, Medium	80x80	\$ 34.50
2374	Weigh Boat, Large	140x140	\$ 67.50

# Transport Tubes

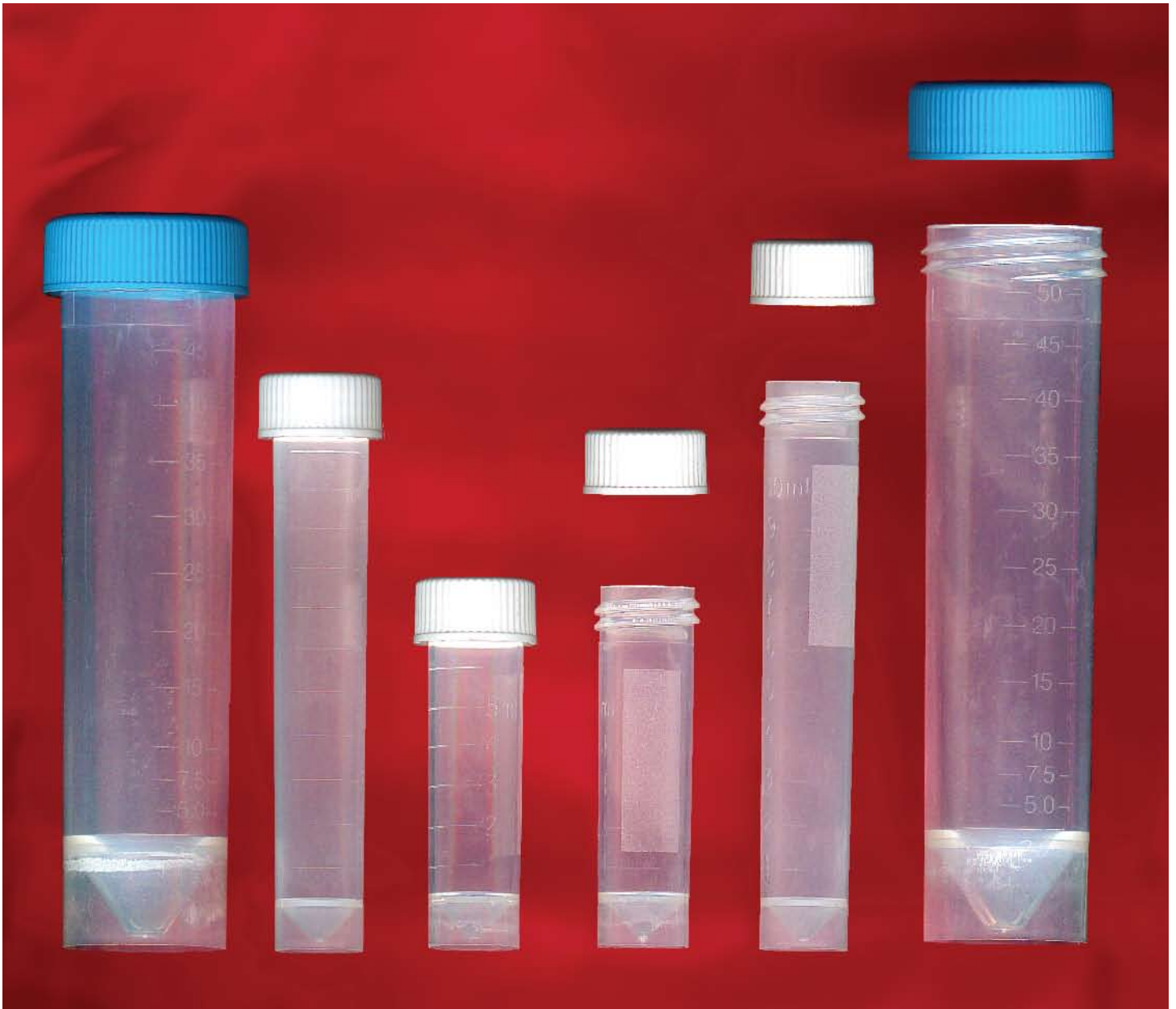

Our screw top transport tubes are ideal for sample collection, sample storage and transport. The strong construction and leak-proof threaded caps make them safe and convenient. Each tube has molded graduation marks and a frosted area for writing sample identification information. The tubes are made from virgin FDA grade polypropylene and the caps are made from virgin

FDA polyethylene. The vials are not autoclavable but we offer them as gamma radiation sterilized. All tubes have an interior conical bottom and an exterior skirt which allows the tubes to stand without a rack. The sterilized tubes have the caps attached. The non-sterile tubes come with the caps in a separate bag.

# Transport Tubes

## 5ml Transport Tube

The dimensions of the 5ml transport tube are:

Tube: Height: 58 mm Diameter(OD): 16 mm Wall: 1 mm

Cap: Height: 11 mm Diameter(OD): 20.5 mm Wall: 2 mm

Total Height with cap attached: 60.5mm

Catalog#	Volume	Sterile	Quantity	Price/pack
2000	5 ml	no	1000	\$ 65.00
2000-S	5 ml	yes	500	\$ 49.00

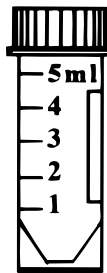

Cat#2000

## 10ml Transport Tube

The dimensions of the 10ml transport tube are:

Tube: Height: 93 mm Diameter(OD): 16 mm Wall: 1mm

Cap: Height: 11mm Diameter(OD): 20.5mm Wall: 2mm

Total Height with cap attached: 94.5mm

Catalog#	Volume	Sterile	Quantity	Price/pack
2010	10 ml	no	1000	\$ 65.00
2010-S	10 ml	yes	500	\$ 55.00

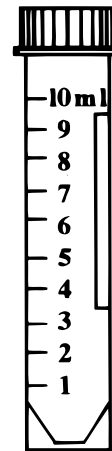

Cat#2010

## 50ml Transport Tube

The dimensions of the 50ml transport tube are:

Tube: Height: 117 mm Diameter(OD): 29mm Wall: 1mm

Cap: Height: 13 mm Diameter(OD): 34.5mm Wall: 2mm

Total Height with cap attached: 120mm

Catalog#	Volume	Sterile	Quantity	Price/pack
2020	50 ml	no	500	\$ 79.00
2020-S	50 ml	yes	500	\$ 109.00

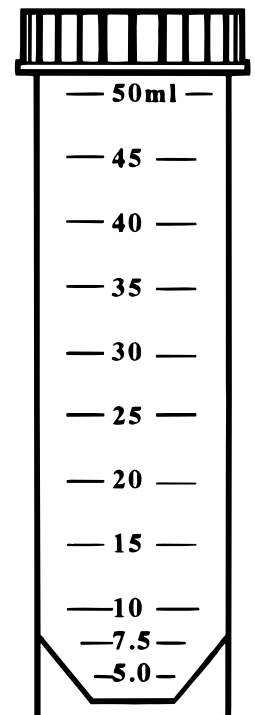

Cat#2020

# Transfer Pipets

## Safe, Easy Liquid Transfer

- \*attached bulb avoids cross-contamination
- \*low-affinity surface keeps retention to a minimum
- \*one step biohazard disposal
- \*can be frozen in liquid nitrogen
- \*made from shatterproof, inert polyethylene
- \*sterile and non-sterile available

No more leaky bulbs, no more searching for lost bulbs. Simply reach into the dispenser box and you will have a chemically clean transfer pipet ready to use. Excellent for blood banking, diluting, serum removal,

aliquoting. The polyethylene material is chemically inert and pliable so that most solvents will not affect either the performance or cause dimensional changes. All transfer pipets are made from low-density polyethylene. This material is inert, non-toxic and has a low affinity surface. We have many designs available, each one designed to make lab procedures easier. Biohazard disposal is simplified as the pipets can be placed in the Bio-Hazard disposal bag for one step disposal. The pipets can be frozen in liquid nitrogen.

The pipets can be purchased by the individual box (quantities vary by pipet type) or by the case. Purchasing by the case offers even greater savings.



Total Length	15.6 cm
Stem Diameter	7.9mm
Total Capacity	7.7ml
Bulb Draw	3.2ml
Drops per ml	20 drops

### Standard Size Transfer Pipet

This transfer pipet is the most commonly used transfer pipet. It is suitable for use in many laboratory applications when there are no special requirements. It is also available sterilized. The single wrap has each individual pipet in its own sterile wrapper. The 20 wrap has 20 pipets per sterile wrapper. The standard package is a box of 500 transfer pipets in a white box with a lid that opens on the top. You can order by the case and save.

Catalog#	Pipet Type	Package	Pipets/Catalog#	Price/Catalog#
TP01-1000	Transfer Pipet	Pack of 500 pipets	500	\$ 19.50
TP01-1050	Transfer Pipet	Case of 10 packs	5000	\$ 169.00
TP01-1101	Sterilized, single wrap	Pack of 500 pipets	500	\$ 41.50
TP01-1150	Sterilized, single wrap	Case of 8 packs	4000	\$ 285.00
TP01-1220	Sterilized, 20 wrap	Pack of 500 pipets	500	\$ 30.50
TP01-1250	Sterilized, 20 wrap	Case of 8 packs	4000	\$ 209.00



Total Length	15.6 cm
Stem Diameter	7.9mm
Total Capacity	7.7ml
Bulb Draw	3.2ml
Drops per ml	20 drops

### Standard Size Transfer Pipet, with graduations

This transfer pipet is the most commonly used graduated transfer pipet. It is suitable for use in many laboratory applications when there are no special requirements. It is also available sterilized. The single wrap has each individual pipet in its own sterile wrapper. The 20 wrap has 20 pipets per sterile wrapper. The standard package is a box of 500 transfer pipets in a white box with a lid that opens on the top. You can order by the case and save.

Catalog#	Pipet Type	Package	Pipets/Catalog#	Price/Catalog#
TP02-4100	Transfer Pipet	Pack of 500 pipets	500	\$ 19.50
TP02-4150	Transfer Pipet	Case of 10 packs	5000	\$ 169.00
TP02-4201	Sterilized, single wrap	pack of 500 pipets	500	\$ 41.50
TP02-4250	Sterilized, single wrap	Case of 8 packs	4000	\$ 285.00
TP02-4320	Sterilized, 20 wrap	pack of 500 pipets	500	\$ 30.50
TP02-4350	Sterilized, 20 wrap	Case of 8 packs	4000	\$ 209.00

# Transfer Pipets



Total Length	15.5 cm
Stem Diameter	4.6 mm
Total Capacity	5.8 ml
Bulb Draw	3.4 ml
Drops per ml	25 drops

## Graduated Transfer Pipet, 1 ml

This transfer pipet is used for dispensing liquids where you need to control the volume within 0 to 1 ml. The graduations are at 0.25, 0.5, 0.75 and 1ml. It is also available sterilized. The single wrap has each individual pipet in its own sterile wrapper. The 20 wrap has 20 pipets per sterile wrapper. The standard package is a box of 500 transfer pipets in a white box with a lid that opens on the top. You can order by the case and save.

Catalog#	Pipet Type	Package	Pipets/Catalog#	Price/Catalog#
TP02-3100	Graduated Transfer Pipet, 1 ml	Pack of 500 pipets	500	\$ 19.50
TP02-3150	Graduated Transfer Pipet, 1 ml	Case of 10 packs	5000	\$ 169.00
TP02-3201	Sterilized, single wrap	pack of 500 pipets	500	\$ 41.50
TP02-3250	Sterilized, single wrap	Case of 8 packs	4000	\$ 285.00
TP02-3320	Sterilized, 20 wrap	pack of 500 pipets	500	\$ 30.50
TP02-3350	Sterilized, 20 wrap	Case of 8 packs	4000	\$ 209.00



Total Length	8.5 cm
Stem Diameter	2.5 mm
Total Capacity	4.0 ml
Bulb Draw	3.0 ml
Drops per ml	25 drops

## Narrow, Short stem, Transfer pipet

This transfer pipet is used for drawing up samples where you have a limited working area. The draw with each squeeze is 3 ml but the stem is quite short so that you keep the length of the pipet to a minimum. The pipets come in a pack of 500 or you can order by the case of 10 packs and save.

Catalog#	Pipet Type	Package	Pipets/Catalog#	Price/Catalog#
TP05-6400	Transfer Pipet, narrow, short stem	Pack of 500 pipets	500	\$ 20.50
TP05-6450	Transfer Pipet, narrow, short stem	Case of 10 packs	5000	\$ 185.00



Total Length	15.5 cm
Stem Diameter	2.5 mm
Total Capacity	4.6 ml
Bulb Draw	3.3 ml
Drops per ml	25 drops

## Narrow stem, Transfer pipet

This transfer pipet is used for drawing up samples where you have a small diameter to draw and dispense your sample. The draw with each squeeze is 3 ml and the stem is a standard length. The pipets come in a pack of 500 or you can order by the case of 10 packs and save.

Catalog#	Pipet Type	Package	Pipets/Catalog#	Price/Catalog#
TP05-7400	Transfer Pipet, narrow stem	Pack of 500 pipets	500	\$ 19.50
TP05-7450	Transfer Pipet, narrow stem	Case of 10 packs	5000	\$ 169.00

# Transfer Pipets



Total Length	14.7 cm
Stem Diameter	4.6 mm
Total Capacity	5.8 ml
Bulb Draw	3.3 ml
Drops per ml	55 drops

### Fine Tip, Standard, Transfer pipet

This transfer pipet is used for drawing up and dispensing samples where you need small drops or very accurate placement of the transferred sample. The draw with each squeeze is 3.3 ml and the stem is a standard length. The pipets come in a pack of 500 or you can order by the case of 10 packs and save.

Catalog#	Pipet Type	Package	Pipets/Catalog#	Price/Catalog#
TP03-3200	Transfer Pipet, fine tip, standard	Pack of 500 pipets	500	\$ 26.50
TP03-3250	Transfer Pipet, fine tip, standard	Case of 10 packs	5000	\$ 215.00



Total Length	10.4 cm
Stem Diameter	3.0 mm
Total Capacity	1.5 ml
Bulb Draw	1.0 ml
Drops per ml	50 drops

### Extended Fine Tip, Small bulb, Transfer pipet

This transfer pipet is used for drawing up and dispensing samples where you need small drops or very accurate placement of the transferred sample. The shorter length and smaller volume are designed for use where sample container size is reduced. The draw with each squeeze is 1.0 ml and the stem is a reduced length. The pipets come in a pack of 400 or you can order by the case of 8 packs and save.

Catalog#	Pipet Type	Package	Pipets/Catalog#	Price/Catalog#
TP03-5200	Transfer Pipet, extended fine tip	Pack of 400 pipets	400	\$ 20.50
TP03-5250	Transfer Pipet, extended fine tip	Case of 8 packs	3200	\$ 139.00



Total Length	15.2 cm
Stem Diameter	7.1 mm
Total Capacity	4.8 ml
Bulb Draw	1.8 ml
Drops per ml	24 drops

### Graduated Blood Bank, Transfer pipet

This graduated transfer pipet is designed for blood banking but is useful for many other procedures. The graduations are at 0.5, 1.0, 1.5 and 2.0ml. The draw with each squeeze is 1.8 ml and the stem is a slightly reduced length. The pipets come in a pack of 500 or you can order by the case of 10 packs and save.

Catalog#	Pipet Type	Package	Pipets/Catalog#	Price/Catalog#
TP02-5100	Transfer Pipet, Blood Bank, 2 ml	Pack of 500 pipets	500	\$ 19.50
TP02-5150	Transfer Pipet, Blood bank, 2 ml	Case of 10 packs	5000	\$ 179.00

# Transfer Pipets

Total Length	22.5 cm
Stem Diameter	5.0 mm
Total Capacity	6.0 ml
Bulb Draw	2.3 ml
Drops per ml	25 drops

## Long (9") stem, Transfer pipet

This transfer pipet is used for reaching into large containers to withdraw and dispense samples. The draw with each squeeze is 2.3 ml. The pipets come in a pack of 400 or you can order by the case of 10 packs and save.

Catalog#	Pipet Type	Package	Pipets/Catalog#	Price/Catalog#
TP06-6500	Transfer Pipet, long stem	Pack of 400 pipets	400	\$ 20.50
TP06-6550	Transfer Pipet, long stem	Case of 10 packs	4000	\$ 185.00

Total Length	30.0 cm
Stem Diameter	8.6 mm
Total Capacity	23.0 ml
Bulb Draw	7.3 ml
Drops per ml	20 drops

## Very Long (12") stem, Transfer pipet

This transfer pipet is used for reaching into large containers to withdraw and dispense large samples. The draw with each squeeze is 7.3 ml. The pipets come in a pack of 100 or you can order by the case of 10 packs and save.

Catalog#	Pipet Type	Package	Pipets/Catalog#	Price/Catalog#
TP06-7500	Transfer Pipet, 12" stem	Pack of 100 pipets	100	\$ 20.50
TP06-7550	Transfer Pipet, 12" stem	Case of 10 packs	1000	\$ 185.00

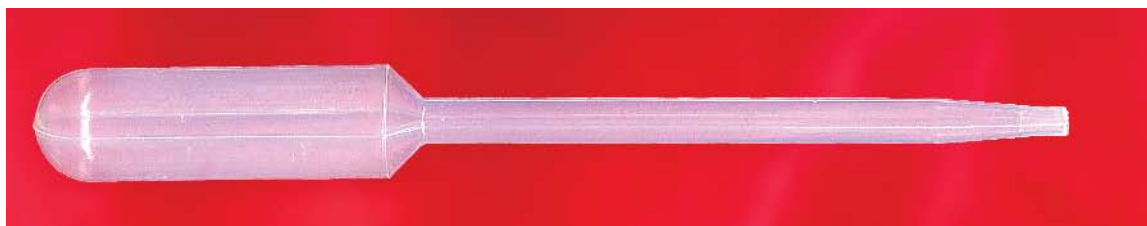

Total Length	13.7 cm
Stem Diameter	6.1 mm
Total Capacity	9.3 ml
Bulb Draw	4.8 ml
Drops per ml	-

## Large Aperture, Transfer pipet

This transfer pipet is used for isolating cell suspensions with minimum of cell disruption. The large aperture prevents cells from being stripped when removed or transferred. You can also use this pipet for the titration of cells and the isolation of platelets from blood and wash. The pipets come in a pack of 250 or you can order by the case of 10 packs and save.

Catalog#	Pipet Type	Package	Pipets/Catalog#	Price/Catalog#
TP01-9000	Transfer Pipet, Large Aperture	Pack of 250 pipets	250	\$ 13.50
TP01-9050	Transfer Pipet, Large Aperture	Case of 10 packs	2500	\$ 115.00



# Perfector Scientific® Disposable Cuvettes

Presorted Standard  
U. S. Postage Paid  
**Permit # 7**  
San Luis Obispo, CA  
93401

## Standard 3.5ml and Semi-Micro sizes

“UV” Transmitting, to 285nm

Fluorometer cuvettes with 4 sides clear

Tight Sealing Caps Available!

We use the finest materials and take the greatest care to ensure that our cuvettes are the best available. Two sizes are available; 3.5ml (standard) and 1.5 ml (semi-micro). All cuvettes have a 10mm path length and are 45mm high. Internal width of the semi-micro size is 4mm. Fluorometer cuvettes have all four sides clear. Cuvettes for use in the visible spectra are made from polystyrene, UV cuvettes are made from methacrylate. The cuvettes will fit all standard instruments. The cuvettes are packed in 5 styrofoam trays, each tray holding 100 cuvettes. The trays have a tight fitting styrofoam lid which protects the optical surfaces and keeps cuvettes clean. We also have cuvette caps made from polyethylene which are easy to insert and remove, but seal liquid tight, suitable for mixing and storage.

## Polystyrene, useable range: 340 to 800nm

Catalog#	Description	Volume	Range(nm)	Qty/pk	Price/pk
<b>9002</b>	Standard	3.5ml	340-800	500	\$ 35.50
<b>9003</b>	Semi-Micro	1.5ml	340-800	500	\$ 41.50
<b>9012</b>	Fluorometer	3.5ml	340-800	500	\$ 40.50

## Caps for Cuvettes, fit all cuvettes listed

Catalog#	Description	Use with	Qty/pk	Price/pk
<b>9020</b>	Caps	all cuvettes	500	\$ 19.50

## Acrylic, useable range: 285 to 800nm

Catalog#	Description	Volume	Range(nm)	Qty/pk	Price/pk
<b>9007</b>	UV Standard	3.5ml	285-800	500	\$ 85.50
<b>9008</b>	UV Fluorometer	1.5ml	285-800	500	\$ 79.50
<b>9014</b>	UV Fluorometer	3.5ml	285-800	500	\$ 78.50

